



CONSTRUCTION MATERIALS
gölgeyap

**WHOLESALE AND RETAIL
PRODUCT CATALOG**





gölgeyap



WHO ARE WE?

Launched in the year 2006, Gölgeyap is a company established with the aim of satisfying fundamental construction needs such as thermal insulation, sound insulation, and waterproofing and providing solutions for construction companies.

Our company is a party to a solution partnership along with the leading companies in the field of insulation and not only it supplies the products of these brands but also carries out the application together with its solution partners.

ROOF COATINGS

01

Roof coating is the leading one among the main insulation practices used for thermal insulation. Buildings are able to provide thermal insulation to a large extent through a roof coating procedure performed on an ironwork.

WATERPROOFING

03

Waterproofing is performed in order to prevent water from pooling up in specific areas of the building, leaking, and damaging the fundamental points of the building. You can choose any solution provided by Gölgeyap for the supply of waterproofing products.

INTERIOR DRYWALL SYSTEMS

05

THERMAL INSULATION

02

Energy conservation has become an intensely emphasized subject with energy resources becoming an important subject in the world. Working with the leading companies in the field, Gölgeyap provides you with various solutions in the field of roof coating together with the expert companies.

SOUND INSULATION

04

Sound insulation is highly important for comfortable and peaceful homes. Insulation of buildings from sound is a common service demanded from construction companies, especially in cities getting crowded.

IRON SHAPE TYPES FOR CONSTRUCTION

06

BUILDING COATING

BUILDING COATING

Building coating solutions are insulation methods preferred to enable thermal insulation in buildings and reduce the tension occurring on the building surface due to thermal differences. Our company Gölgeyap provides companies with solution offers such as siding and coating by the leading companies in the field such as Energytherm and Bonus.

Which companies do we work with for building coating?

✓ *As a supplying and applying company, Gölgeyap works with leading companies in the field such as Capatech, Filli Boya, and Nuh Gazbeton. You can access all the products you need for building coating and sheathing with Gölgeyap distinction. There are building coating options such as XPS, EPS, Rockwool, and Autoclaved Aerated Concrete among the products you can choose in our company.*

Which companies do we work with for building coating?

✓ *Our company is an expert not only in the field of insulation solutions such as thermal insulation, sound insulation, waterproofing, etc. but also in the field of building coating and offers you various solutions. You can always consult Gölgeyap and its team of experts for the supply and application of building coating products.*

WHY BUILDING COATING IS IMPORTANT?

Building coating is extremely important for the protection of buildings from external factors. As a critical factor in the modern construction sector today, building coating is one of the solutions preferred for the protection of the exterior surfaces of buildings, thermal insulation, sound insulation, and waterproofing. It must be performed by experienced teams of experts. You can choose among the product options by Gölgeyap, particularly for thermal and sound insulation.

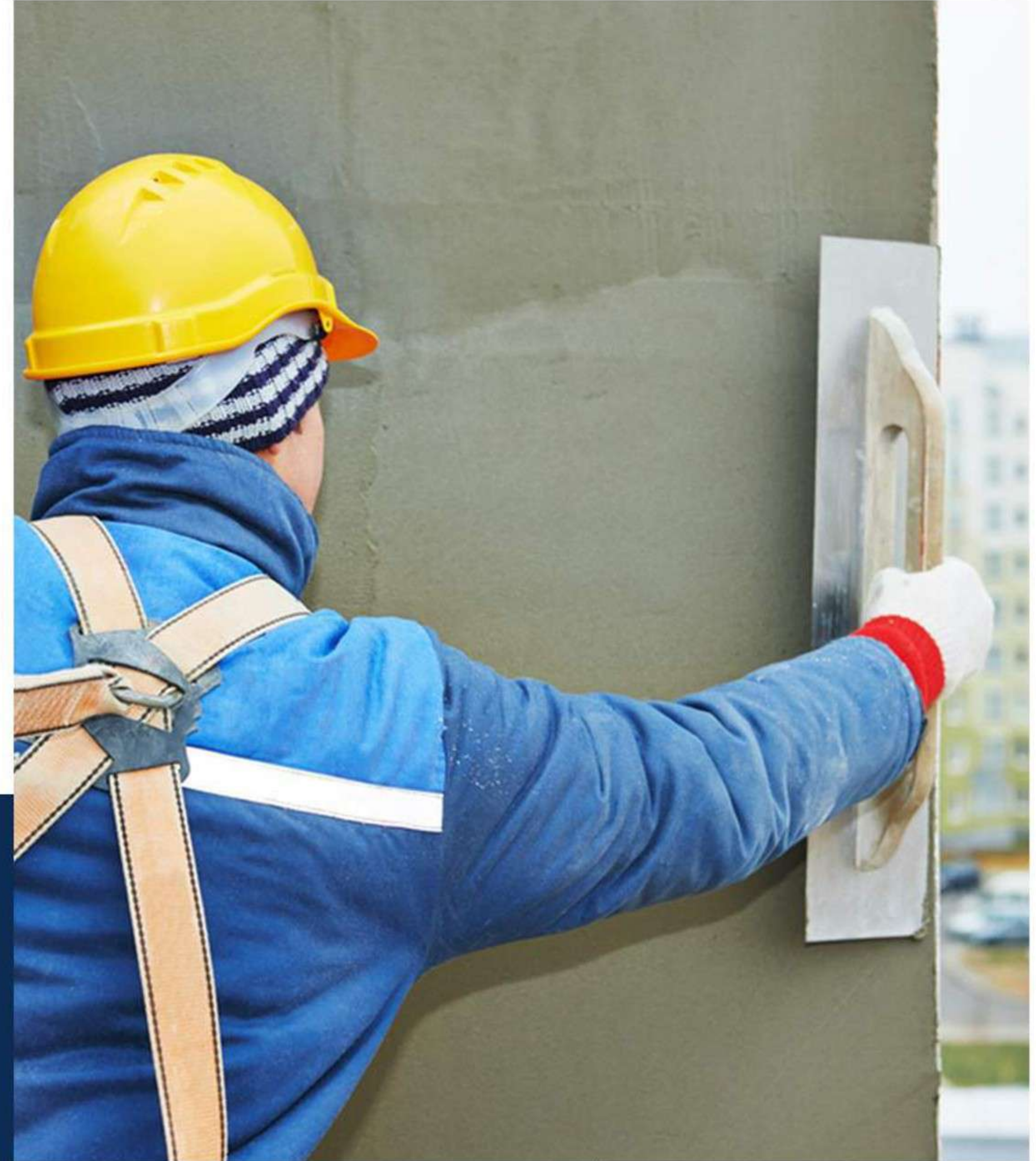

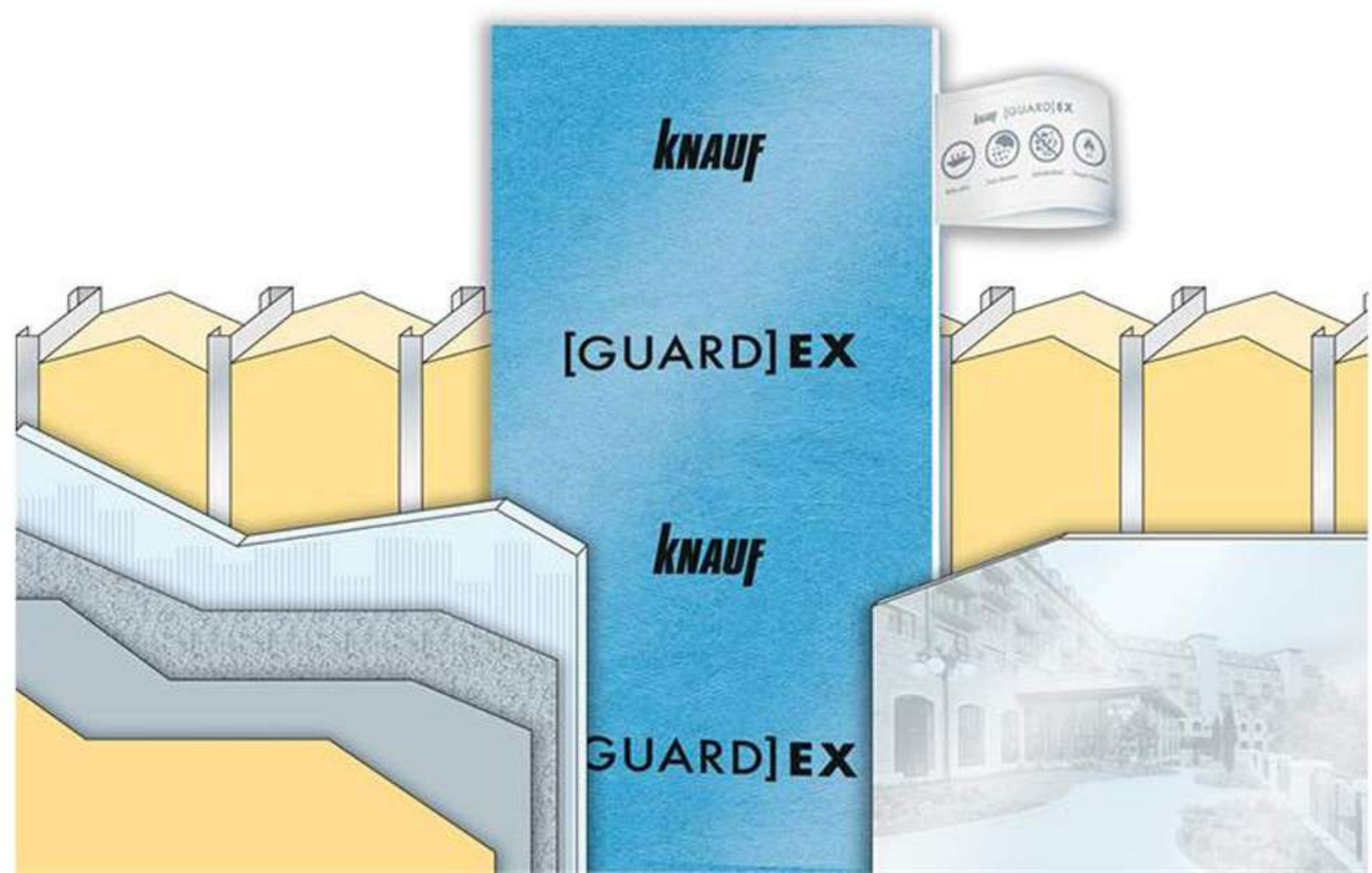
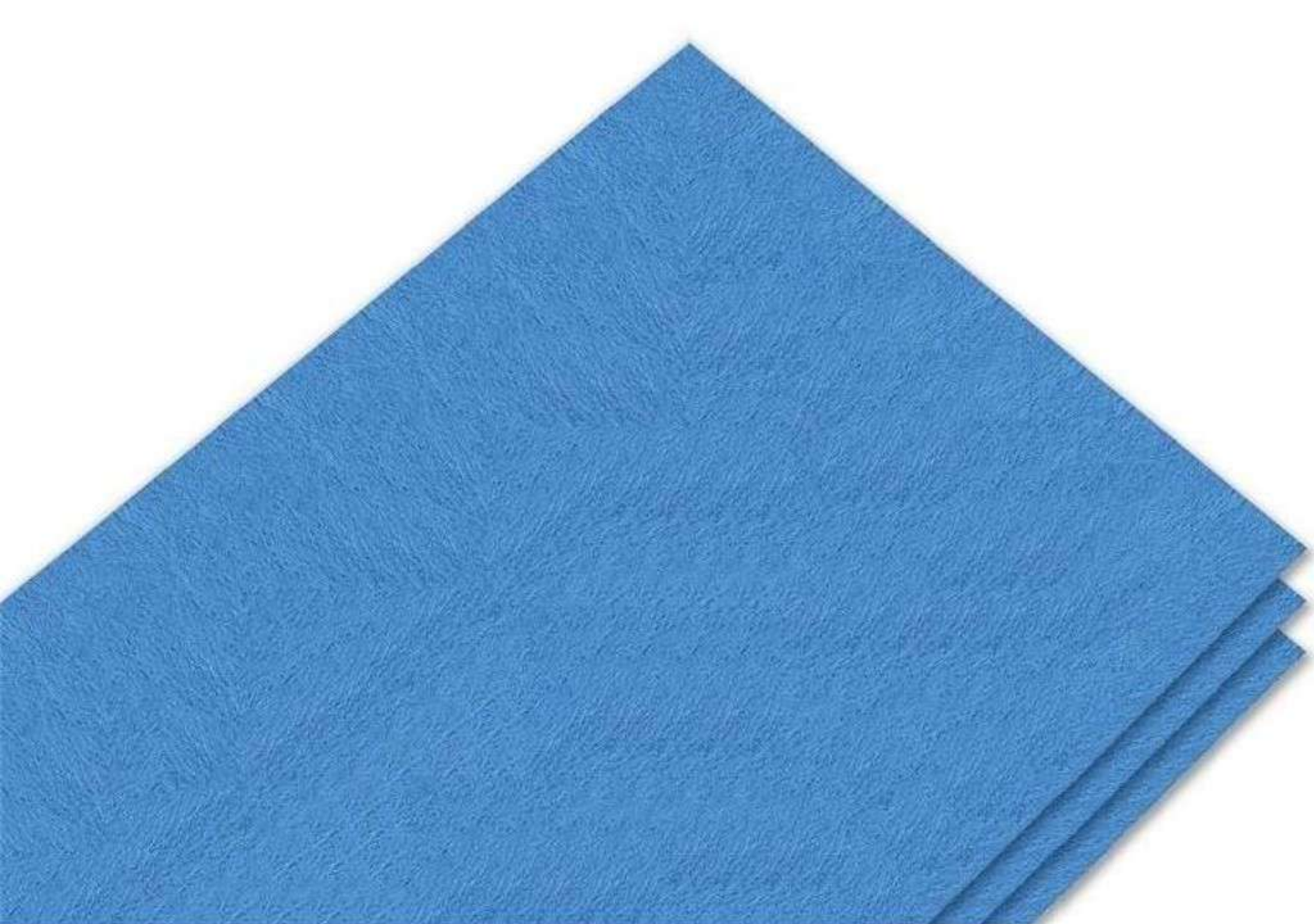



DALSAN

corex





boardex
exterior sheathing







Rigips



ENTEGRE

"Yapının her yerinde"



METAL

SUSPENDED CEILING

CONSTRUCTION MATERIALS
gölgeyap

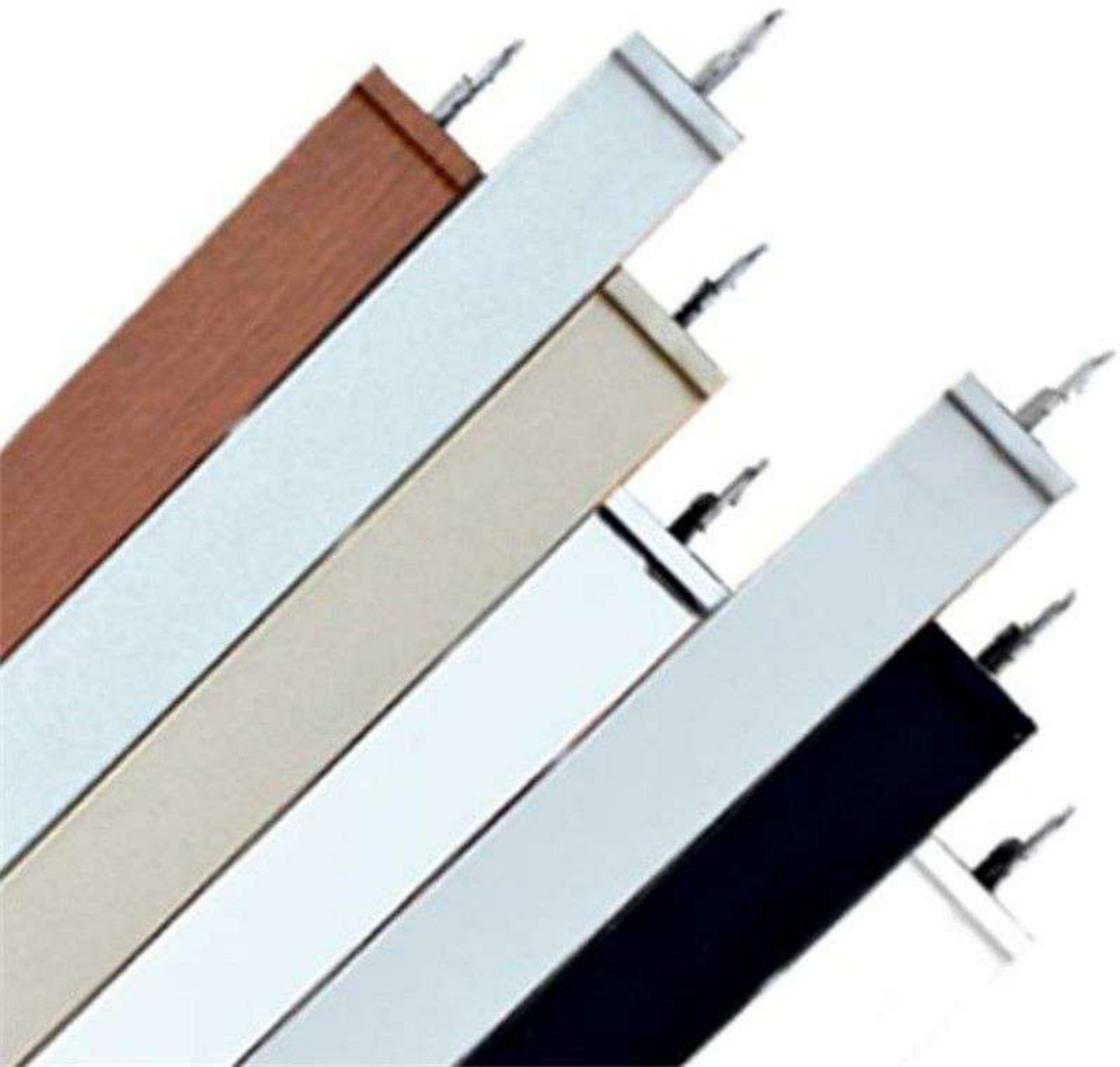

CLIP-IN SUSPENDED CEILING

gölgeyap

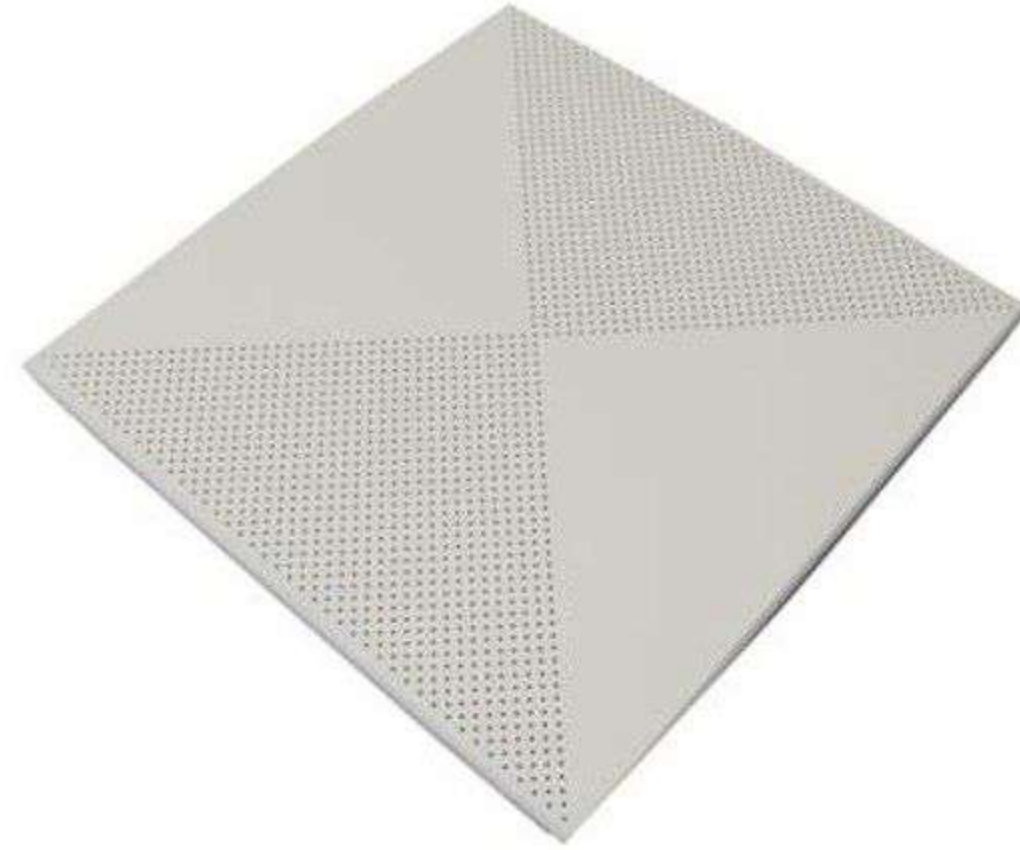

DRYWALL

ACCESSORIES

DRYWALL ACCESSORIES

gölgeyap



DRYWALL SCREW
3,5 X 25 MM



CLIP



HANGER TONGS



ATTACHING FITTING



SLIDE
7,5 CM



DETAIL U PROFILE



LENGTH: 270 - 300 CM
DIMENSION: 23 X 23
UNITS PER PACKAGE: 50



CEILING C PROFILE



WALL C75 PROFILE



WALL U75 PROFILE



CEILING U PROFILE



WALL C100 PROFILE



WALL U50 PROFILE



CEILING C PROFILE



WALL C75 PROFILE



WALL U75 PROFILE



CEILING U PROFILE



WALL C100 PROFILE



WALL U50 PROFILE

THERMAL INSULATION

THERMAL INSULATION

THERMAL INSULATION SOLUTIONS BY GÖLGEYAP

Productive use of energy is a matter in question not only in our country but also in the whole world. We are also aware of the importance of thermal insulation when the point in question is construction.

If you are searching for a company to supply high-quality brands and perform applications together with their team of experts, you can always choose Gölgeyap with years of expertise.



Materials and team of experts for high-quality thermal insulation

01

You can choose Gölgeyap for thermal insulation materials of which thermal conduction is much lower in accordance with CES and ISO values. Our company provides you with various solutions regarding not only the supply of thermal insulation materials but also the application of these materials on the buildings with its team of experts.

You can reach high-quality brands of thermal insulation through Gölgeyap

02

If you wish to have access to thermal insulation products of various brands in the field of exterior insulation such as Filli Boya, Capatect, Baumit, Nuh Gazbeton, etc. in addition to the companies of thermal insulation materials such as Energytherm and Bonus provided by Gölgeyap, you can contact Gölgeyap and easily reach thermal insulation material types such as EPS, XPS, Autoclaved Aerated Concrete, and Rockwool provided by ourselves.

Gölgeyap is assertive in terms of sheathing solutions

03

Various tensions occur on the building surfaces due to thermal differences. The sheathing is among the methods used for both thermal insulation and to reduce the tension on the exterior building. You can choose Gölgeyap for sheathing applications and materials if you wish to protect the exterior surfaces of the buildings and enable quality thermal insulation.

Thermal insulation requires experience

04

Thermal insulation is a highly important subject for the construction industry today since energy is an essential resource for the whole world and thermal insulation enables significant energy conservation within 2-3 years following its application on buildings and structures. You can benefit from the product range and experience of Gölgeyap if you are searching for an expert thermal insulation company for your building and structure.



gölgeyap

The text 'gölgeyap' is written in a white, bold, sans-serif font with a thin white underline, positioned in the bottom left corner of the image.

KNAUFFINSULATION



gölgeyap

KNAUFINSULATION



gölgeyap

KNAUFINSULATION



GÖRÜŞÜYÜZ

AS





PAN
XPS

gölgeyap



Capatect®

ISI YALITIM SİSTEMİ

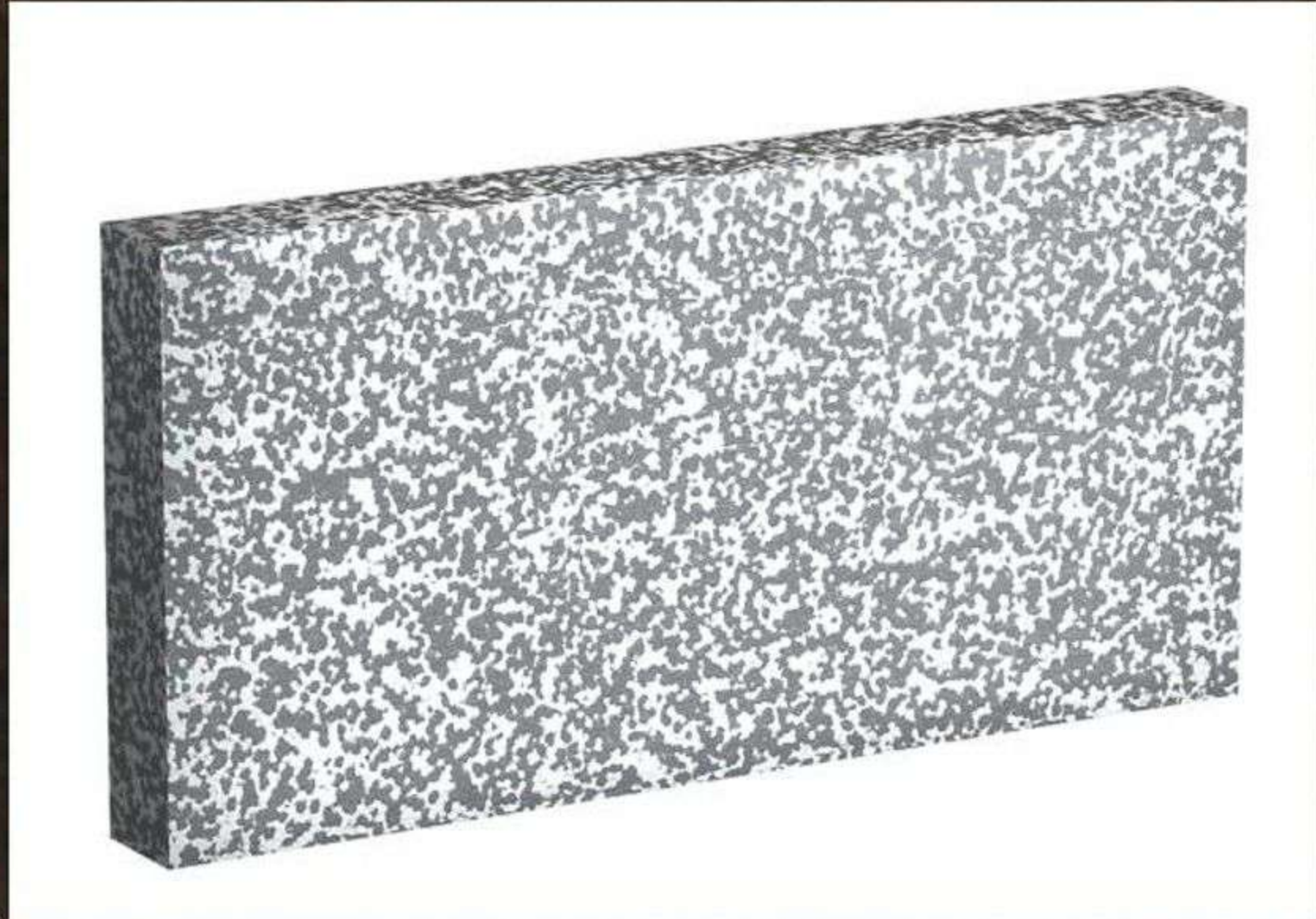

gölgeyap

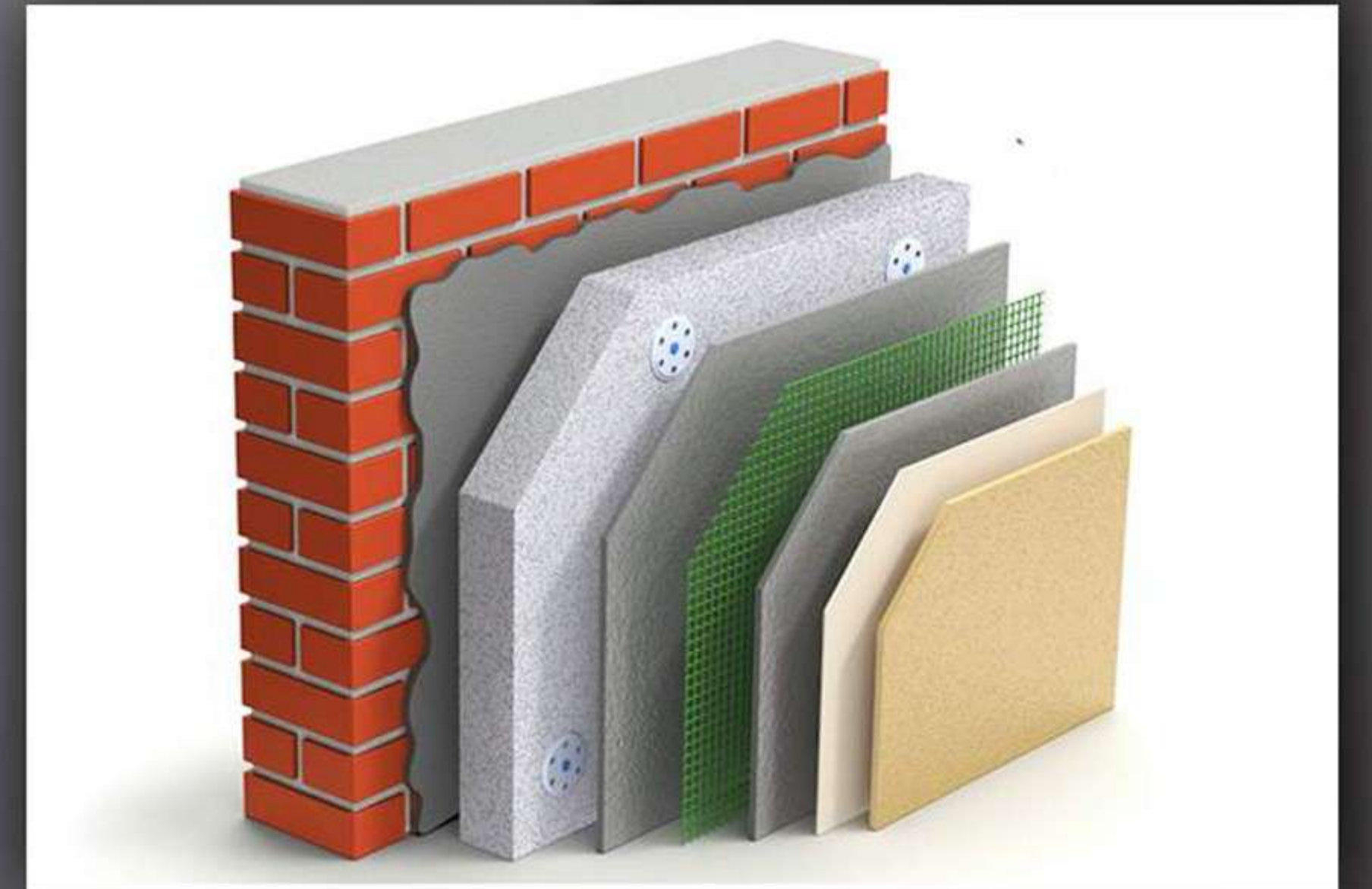

EPS THERMAL INSULATION



WATERPROOFING

WATERPROOFING

Everyone agrees on the importance of water for modern living spaces. However, transportation of water to each floor of a building is an important subject requiring experience just as unintended leaking of water is a serious and unwanted situation.

This shows us the importance of waterproofing for modern structures. You can consult Gölgeyap for wholesale material supply and application regarding waterproofing and choose among the solution options we provide for you.

Reviewing the points to consider regarding waterproofing, you can see for yourself the importance and seriousness of the first recommendation made to you, which is the “material selection.” We, as Gölgeyap, are also aware of the importance of waterproofing and material selection in this regard.

For these reasons, Gölgeyap is a party-to-solution partnership with the leading companies in the field of waterproofing such as Baumit and Weber.

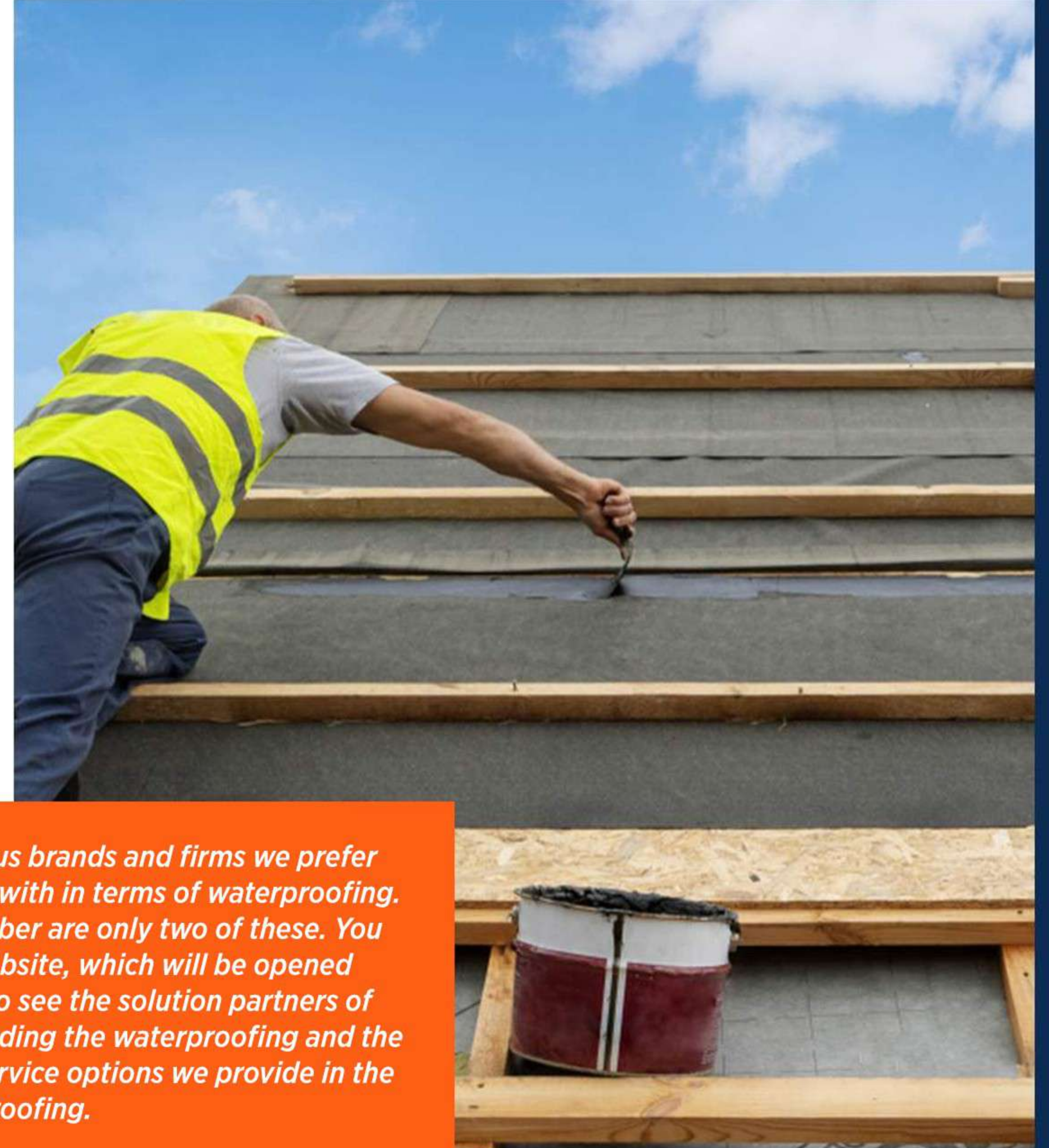

01

Gölgeyap works with companies such as Weber and Baumit in the field of waterproofing. You can supply various materials for waterproofing with Gölgeyap distinction and if you wish, you can choose among the solution options offered by Gölgeyap regarding the applications.

02

There are various brands and firms we prefer and partner up with in terms of waterproofing. Baumit and Weber are only two of these. You can visit our website, which will be opened soon, in order to see the solution partners of Gölgeyap regarding the waterproofing and the material and service options we provide in the field of waterproofing.

Onduline®

gölgeyap



ONDULINE HR SHEET 2000 X 960 X 3 MM RED

Width: 97 cm
Length: 200 cm
Net coverage per sheet: 1.62 m²/sheet
Weight: 6.5 kg + 0.3 kg
Corrugation height: 3.8 cm
Number of corrugations:
10 corrugations/sheet



NEWOLINE HR SHEET 2000 x 940

Net coverage per sheet: 1.58 m
Corrugation height: 38 mm
Number of corrugations:
10 corrugations/sheet
Package: 350 sheets/Pallet



ONDULINE HR ROOF RIDGE 2000 x 485 mm RED

Width x Length: 48.5 cm x 200 cm
Weight: 2.75 kg/ridge
Package: 20 ridges/Package
25 packages/Pallet
500 ridges/Pallet



ONDULINE MEMBRANE

GÖLGEYAP
A.Ş.

focus
membran

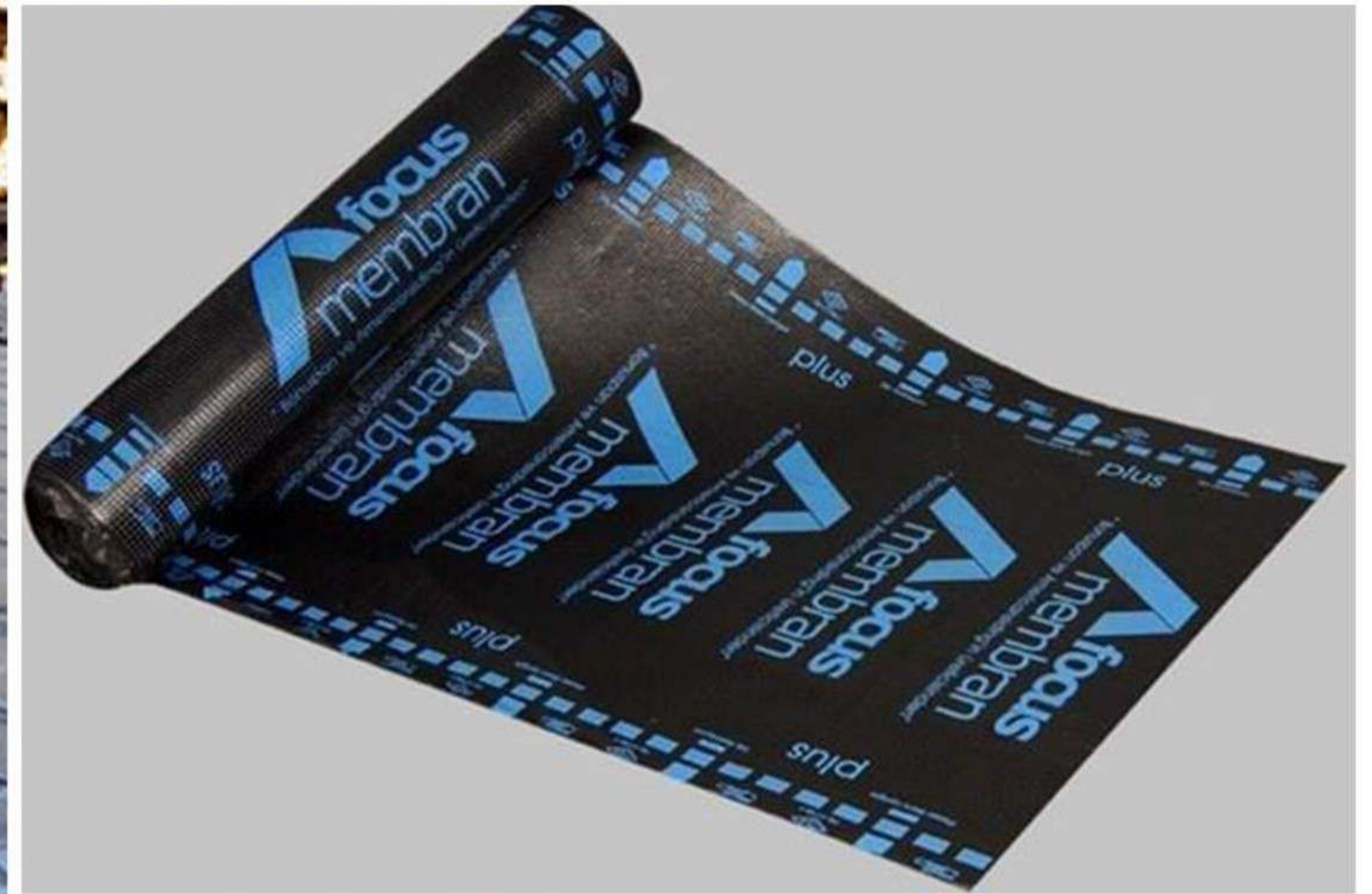

Kalekim®

SEMI - AND PERFECTLY ELASTIC REPAIR MORTARS



UKS[®]

gölgeyap



gölgeyap

E EGGER

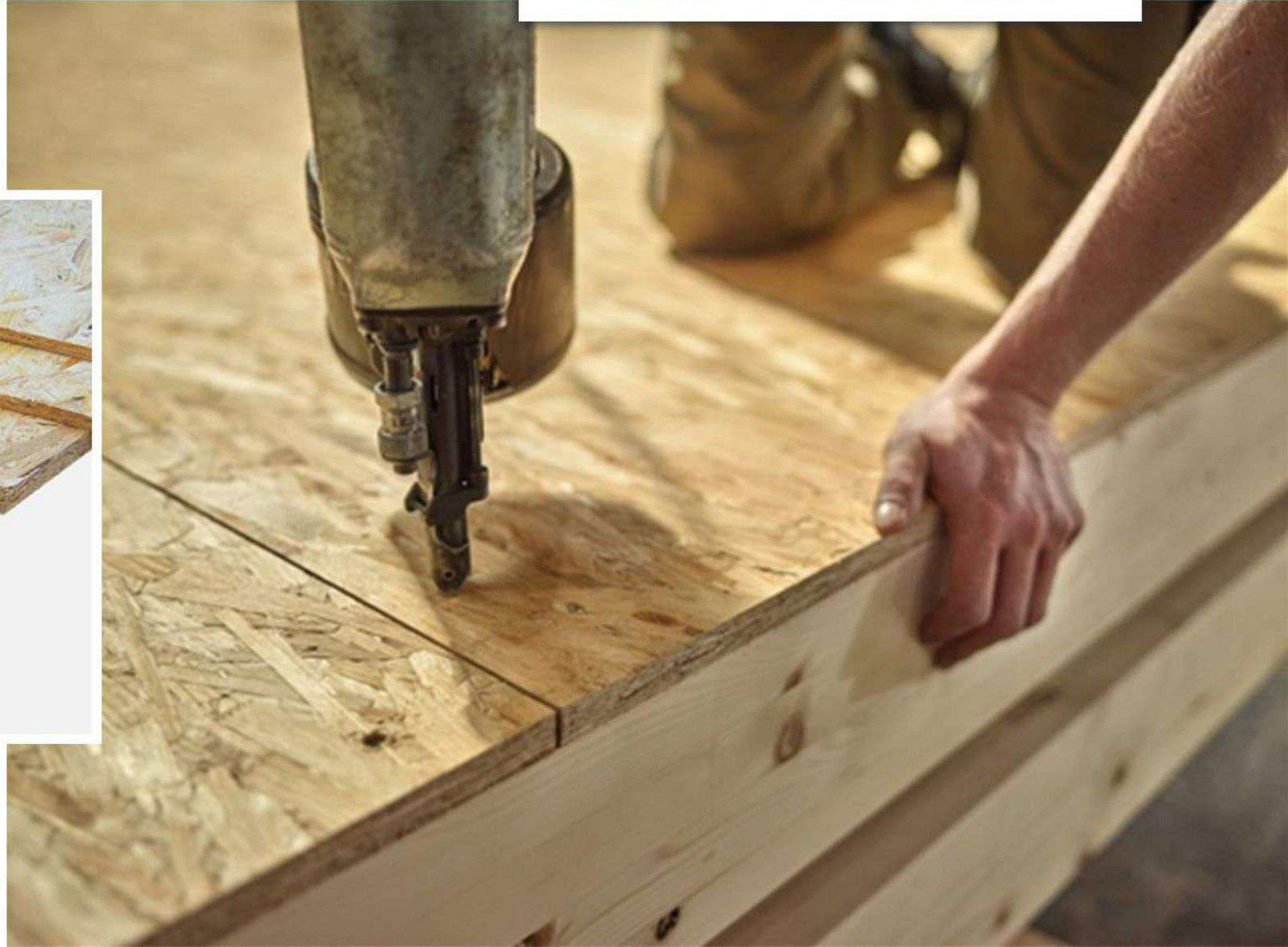

kronospan

gölgeyap



CONSTRUCTION CHEMICALS

gölgeyap

weber
SAINT-GOBAIN



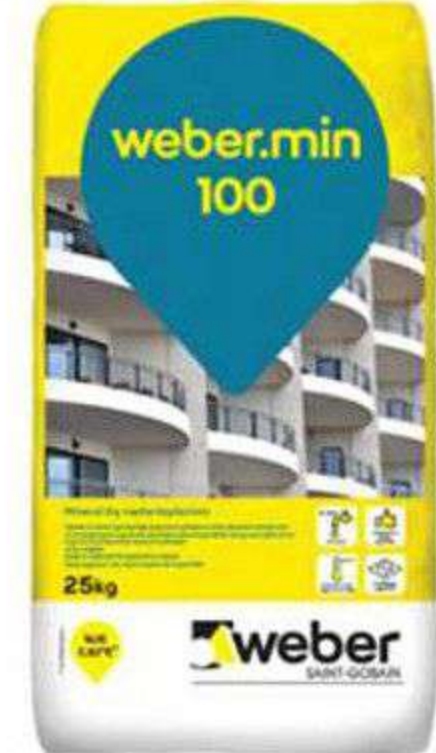
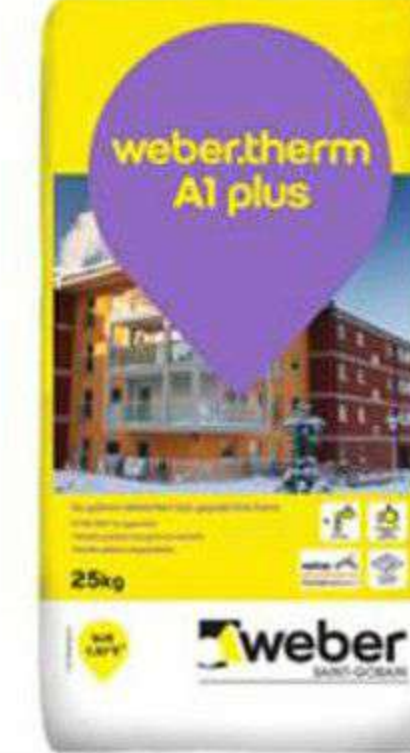

Baumit

gölgeyap



gölgeyap

TEKNO

YAPI KİMYASALLARI



 **Kalekim**®

gölgeyap



gölgeyap

ENTEGRE

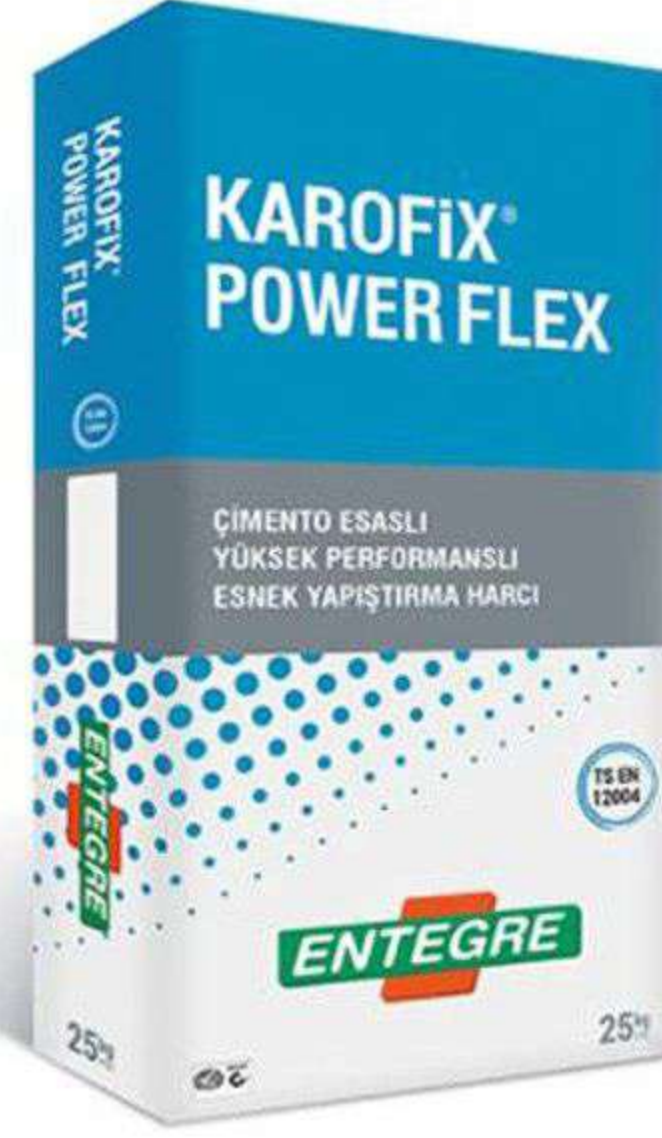
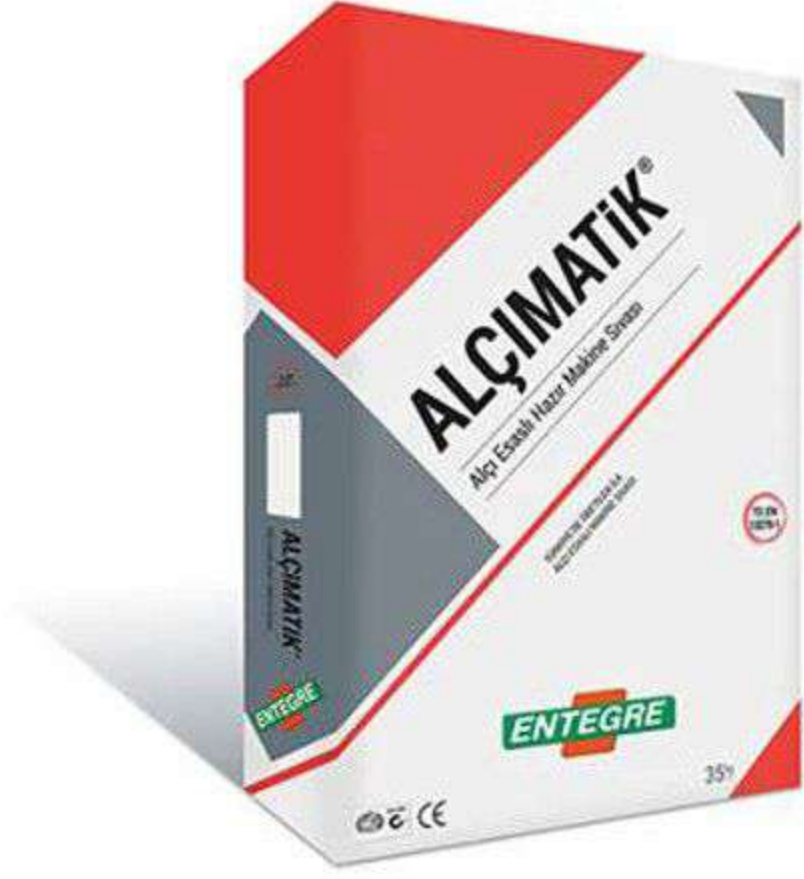

SOUND INSULATION

SOUND INSULATION

Sound insulation is a highly important subject for the modern structures in which an increasing number of people live. It is an essential factor for a structure, especially in crowded cities.

Our company Gölgeyap is aware of the importance of sound insulation for a modern structure and provides you with various options regarding the wholesale supply and application of sound insulation materials. The main benefits of sound insulation that is commonly used in modern construction and engineering are as follows:

01

Sound insulation enables comfort and peace in living spaces.

02

Sound insulation promotes work productivity increase in offices and workspaces.

03

Sound insulation enables the insulation of houses and offices, especially the ones near the industrial facilities from noise.

04

Sound insulation is highly important in terms of preventing noise pollution.

05

Sound insulation is more important for schools and classes in which education is provided and it has a primary effect on the quality of education.

06

Rockwool, which is used for sound insulation, is also a material acting as a protective in cases such as fire.



gölgeyap

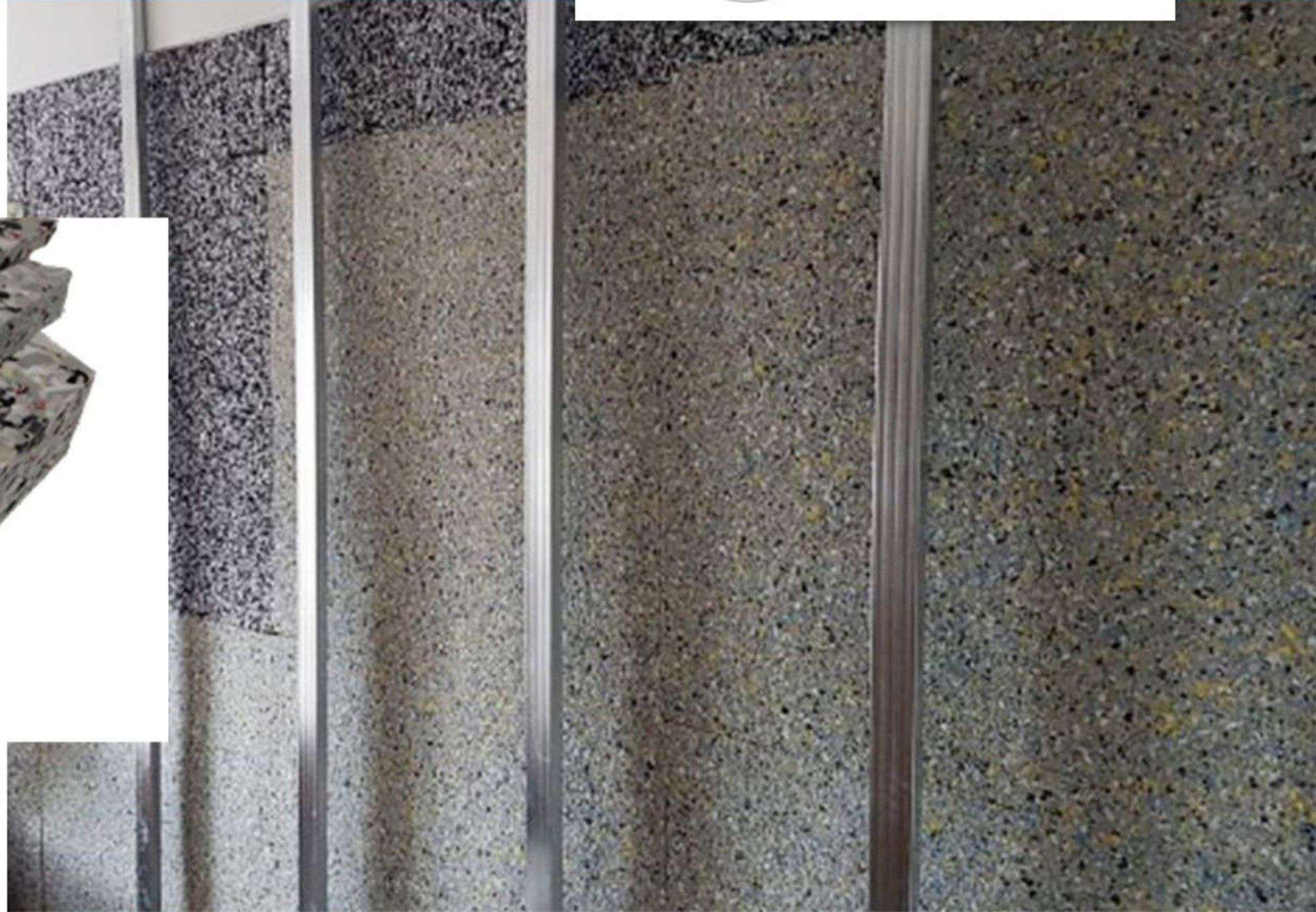

SOUNDPROOFING FOAM

gölgeyap

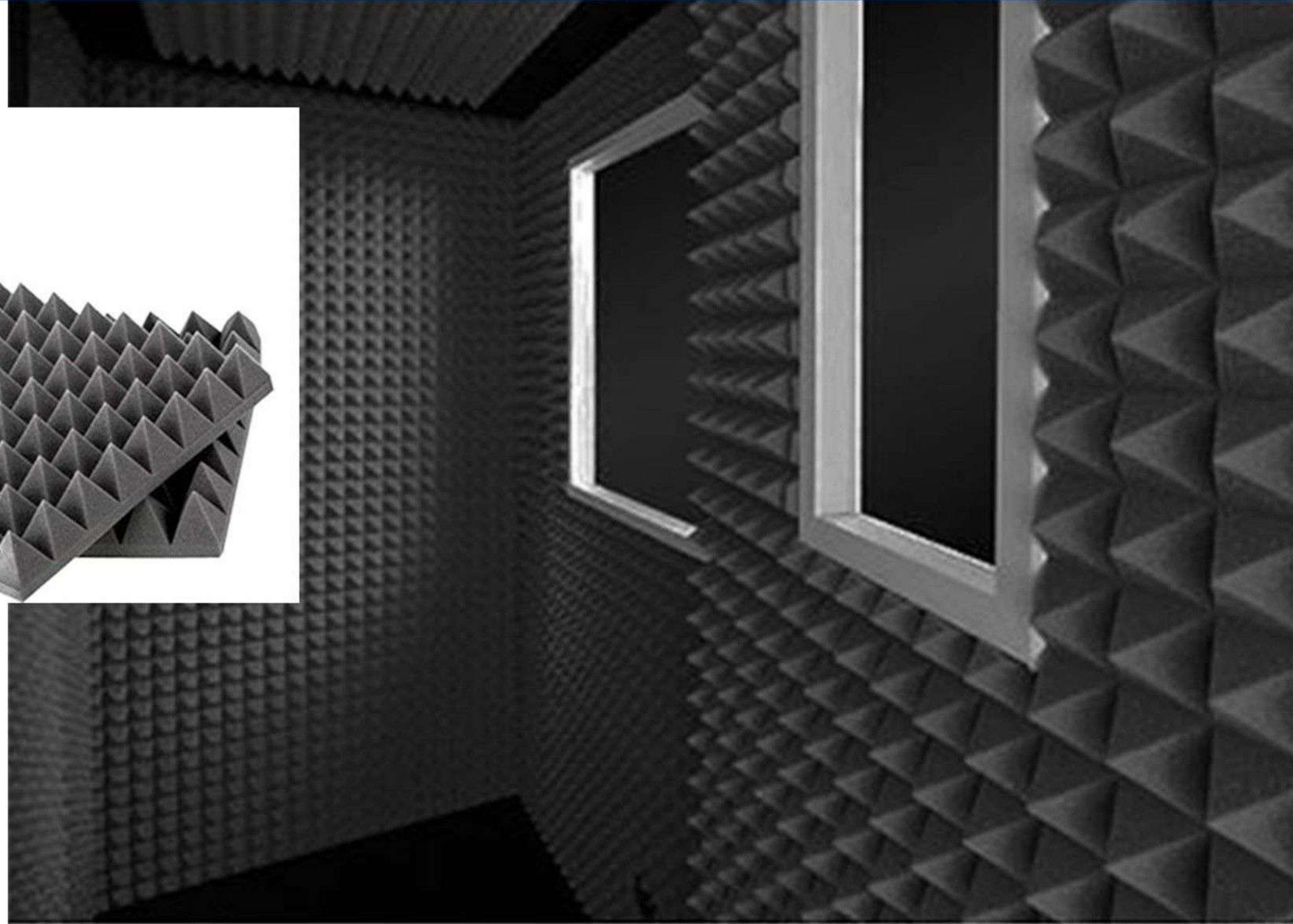

PIPE INSULATIONS

gölgeyap



armacell[®]

MAKING A DIFFERENCE AROUND THE WORLD



RUBBER TAPE

GÖLGEYAP
A.Ş.



10 CM



7,5 CM



5 CM



gölgeyap

RUBBER SHEET



PAINTS



JOTUN

gölgeyap

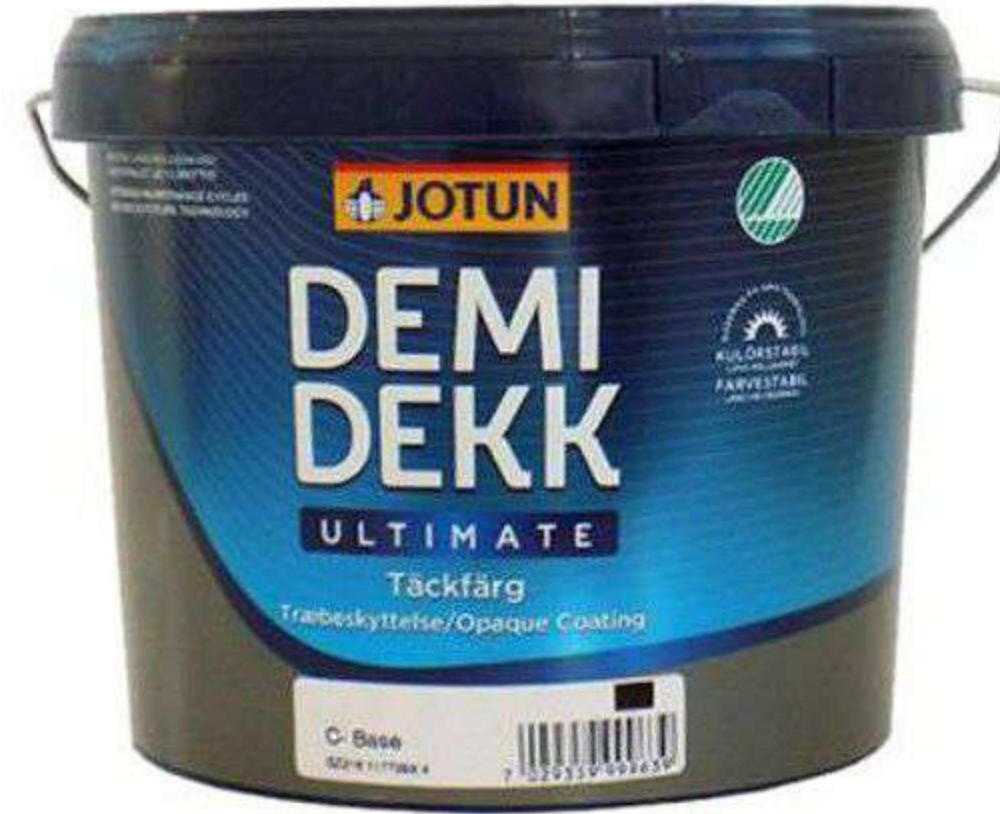

gölgeyap

Filli Boya





gölgeyap

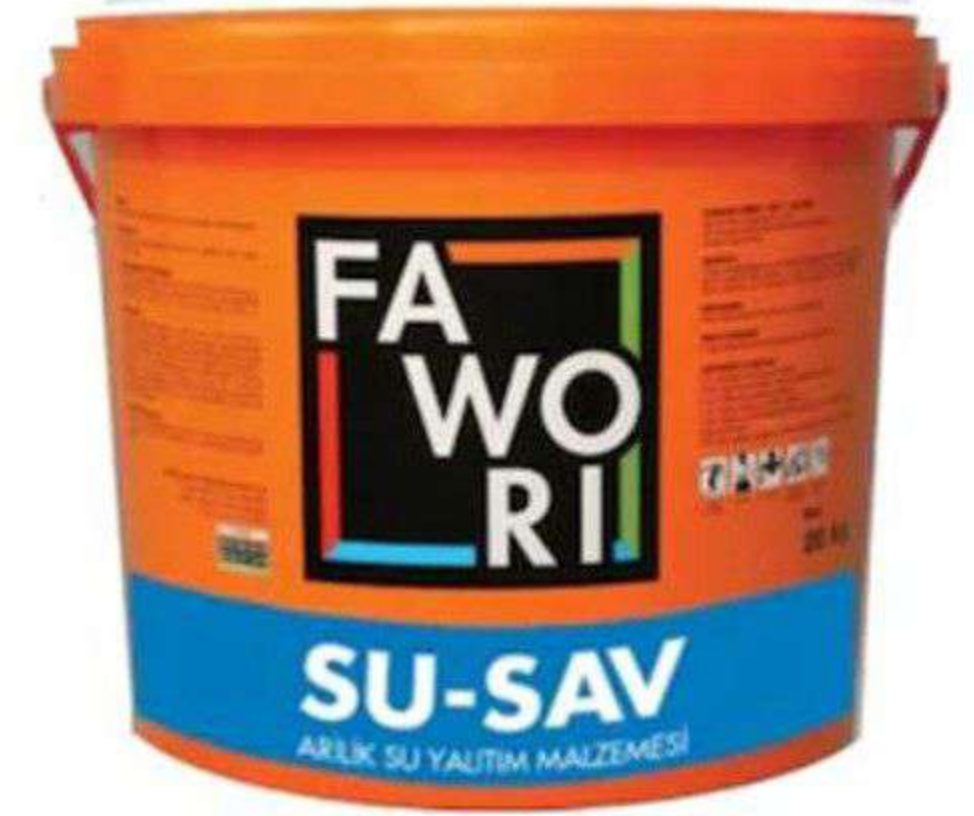

gölgeyap

dyo



Marshall

gölgeyap



gölgeyap



Polisan

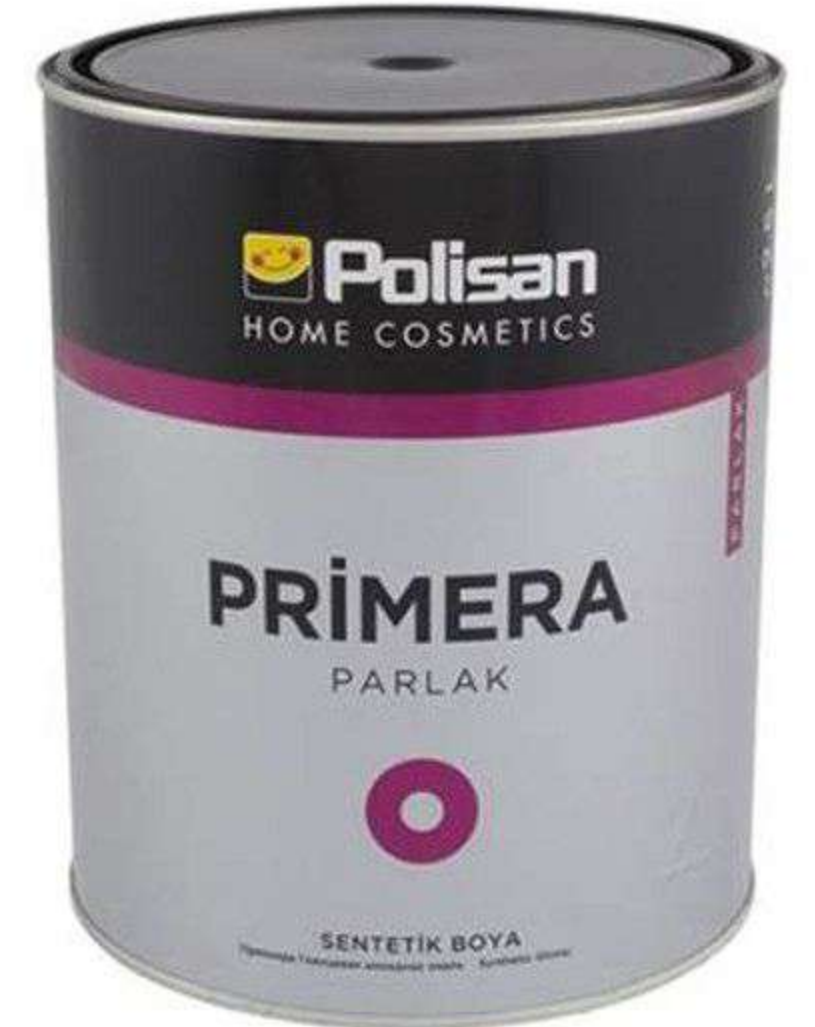

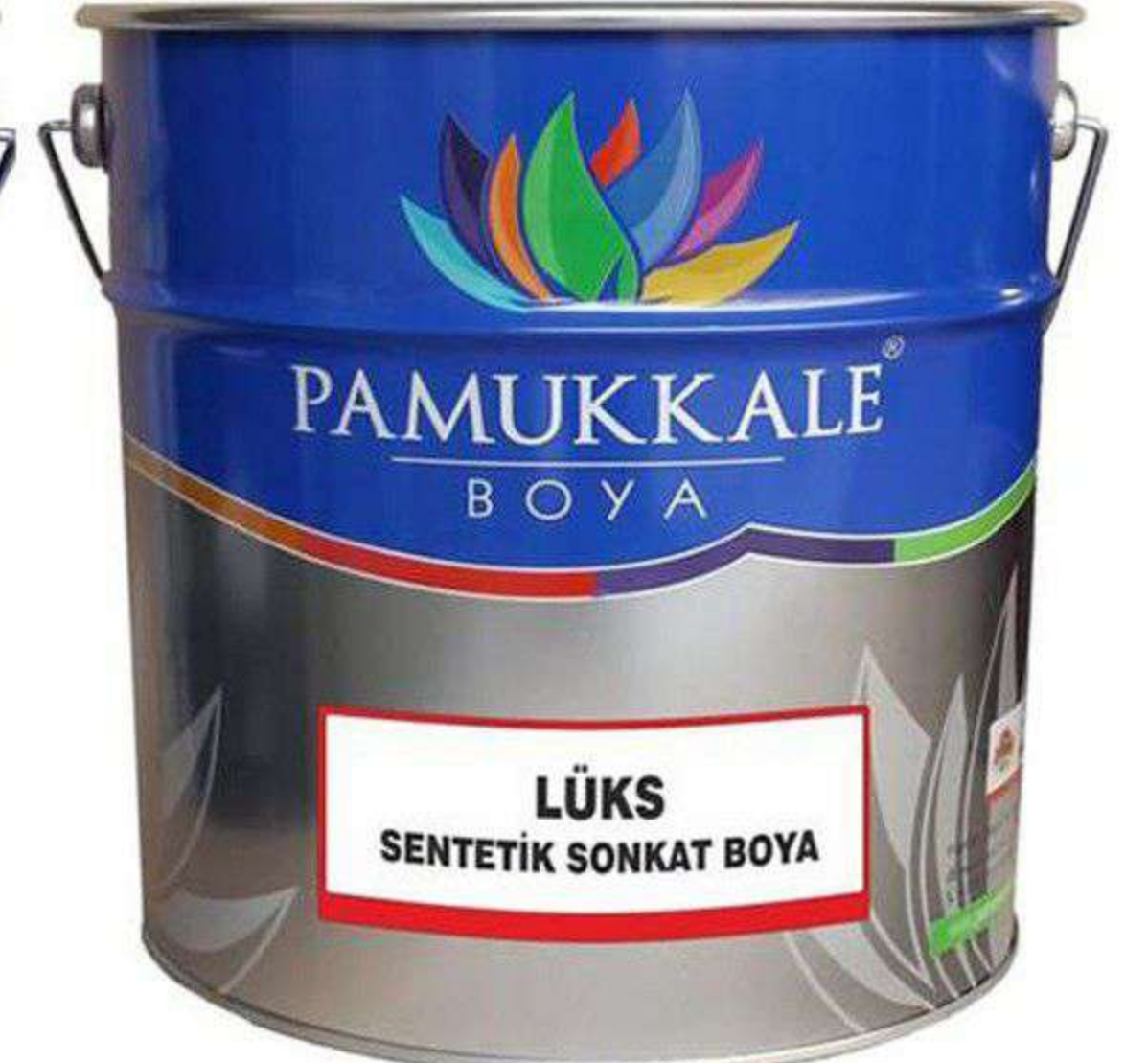

AUTOCLAVED AERATED CONCRETE

STANDARD DIMENSIONS	PRECISION WALL BLOCKS	PROFILE WALL BLOCKS	U BLOCKS	INFILL BLOCKS	INSULATING PLATES
LENGTH (I) CM	60	60	60	60	60
WIDTH (B) CM	25	25	25	40	25
THICKNESS (D) CM	7,5 - 35	15 - 35	7,5 - 35,20, 25.30	25,37,5	5,7,5

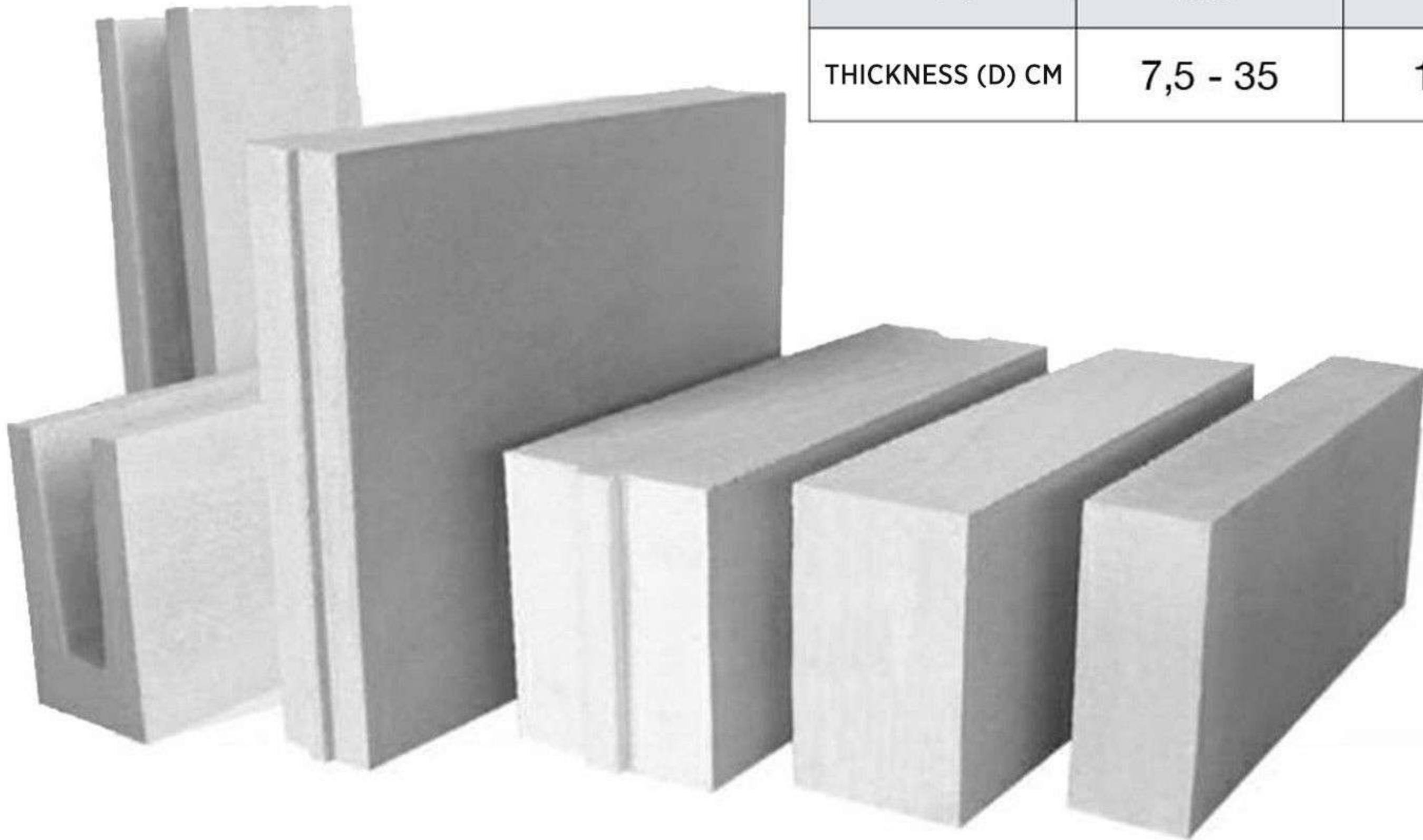

STANDARD DIMENSIONS	PRECISION WALL BLOCKS	PROFILE WALL BLOCKS	U BLOCKS	INFILL BLOCKS	INSULATING PLATES
LENGTH (L) CM	60	60	60	60	60
WIDTH (B) CM	25	25	25	40	25
THICKNESS (D) CM	7,5 - 35	15 - 35	7,5 - 35,20,25.30	25,37,5	5,7,5

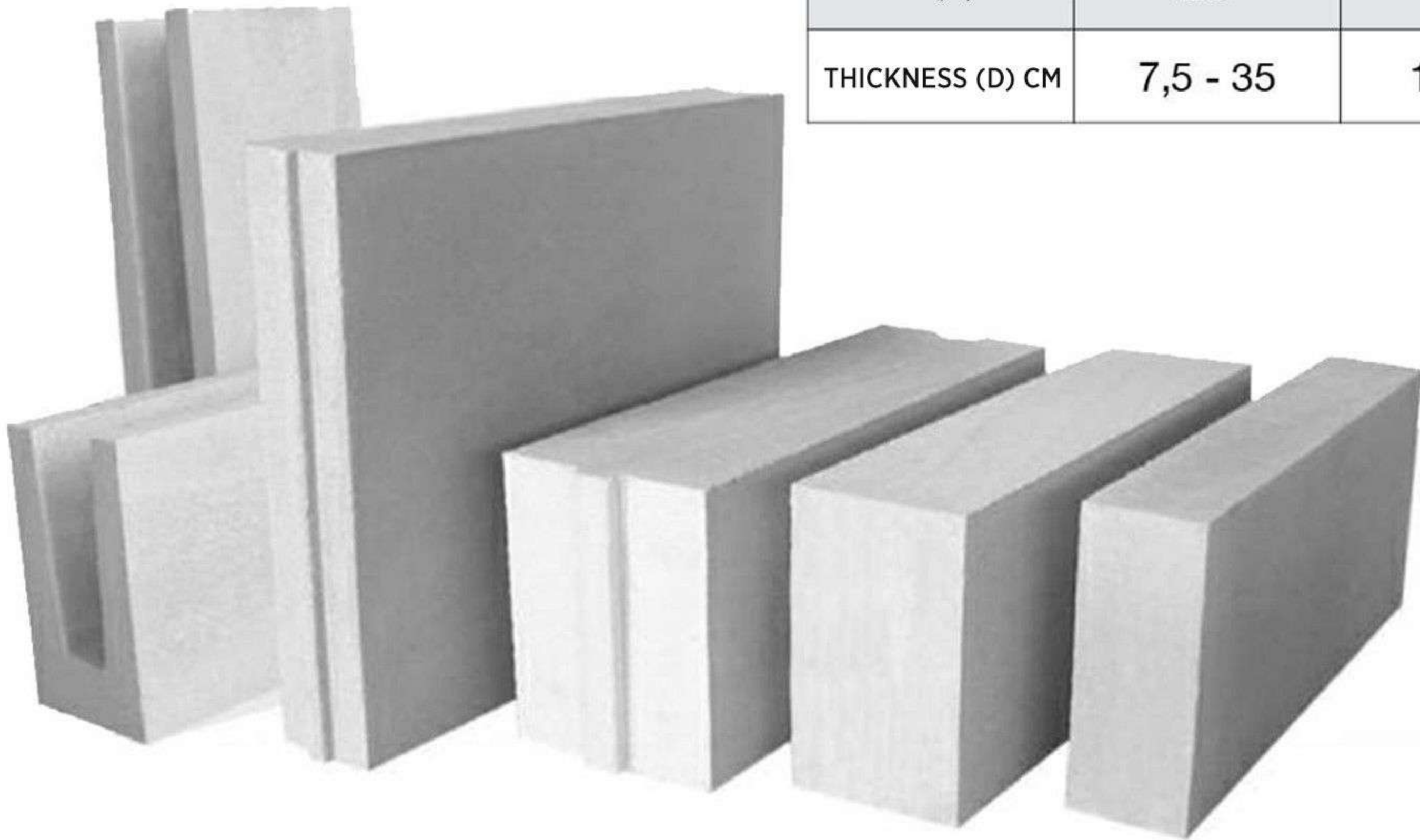



PRODUCT NAME	TWO-LINE HOLLOW BLOCK
PRODUCT DIMENSIONS (cm)	10 x 39 x 18,5
PER 1 m2 WALL (block)	12,5
CARGO WEIGHT (kg/block)	6



PRODUCT NAME	TWO-LINE HOLLOW BLOCK
PRODUCT DIMENSIONS (cm)	19 x 39 x 18,5
PER 1 m2 WALL (block)	12,5
CARGO WEIGHT (kg/block)	11



PRODUCT NAME	TWO-LINE HOLLOW BLOCK
PRODUCT DIMENSIONS (cm)	15 x 39 x 18,5
PER 1 m2 WALL (block)	12,5
CARGO WEIGHT (kg/block)	9



PRODUCT NAME	TWO-LINE HOLLOW BLOCK
PRODUCT DIMENSIONS (cm)	25 x 39 x 18,5
PER 1 m2 WALL (block)	12,5
CARGO WEIGHT (kg/block)	12,5



PRODUCT NAME	TWO-LINE HOLLOW BLOCK
PRODUCT DIMENSIONS (cm)	10 x 39 x 18,5
PER 1 m2 WALL (block)	12,5
CARGO WEIGHT (kg/block)	6



PRODUCT NAME	TWO-LINE HOLLOW BLOCK
PRODUCT DIMENSIONS (cm)	19 x 39 x 18,5
PER 1 m2 WALL (block)	12,5
CARGO WEIGHT (kg/block)	11



PRODUCT NAME	TWO-LINE HOLLOW BLOCK
PRODUCT DIMENSIONS (cm)	15 x 39 x 18,5
PER 1 m2 WALL (block)	12,5
CARGO WEIGHT (kg/block)	9



PRODUCT NAME	TWO-LINE HOLLOW BLOCK
PRODUCT DIMENSIONS (cm)	25 x 39 x 18,5
PER 1 m2 WALL (block)	12,5
CARGO WEIGHT (kg/block)	12,5

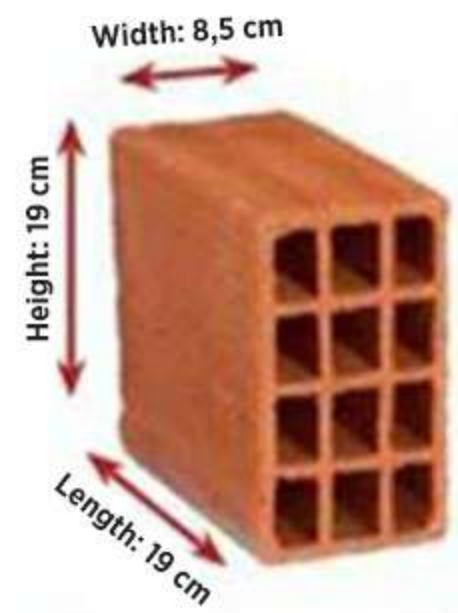

8,5 - Brick

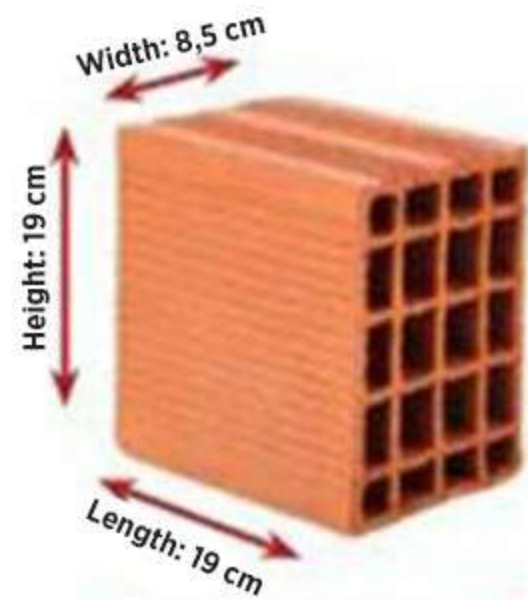

13,5 - Brick

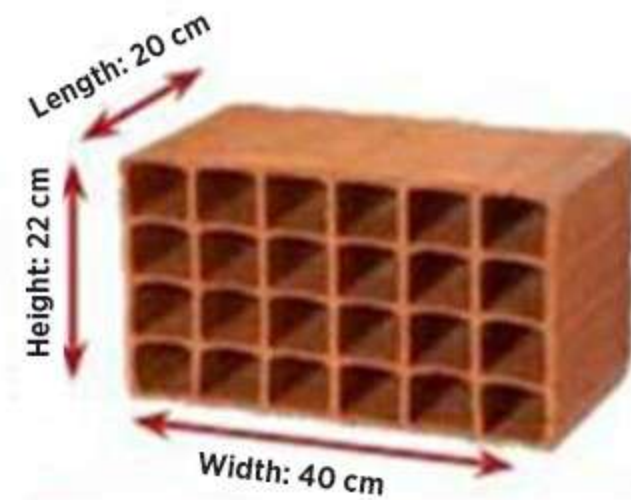

22,5 - Infill Brick

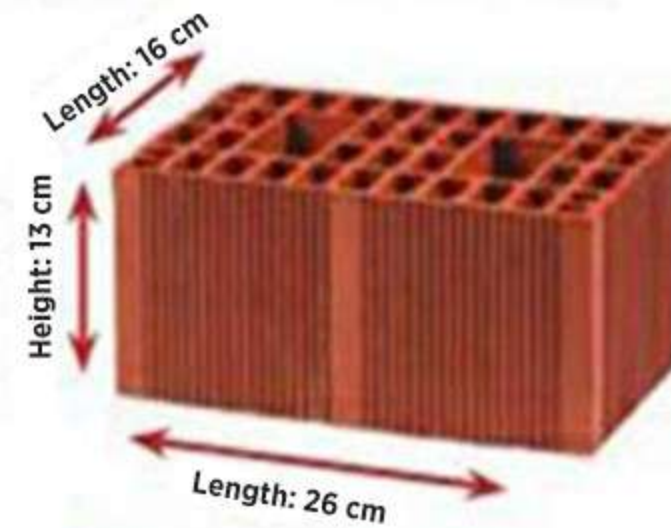

Masonry Brick

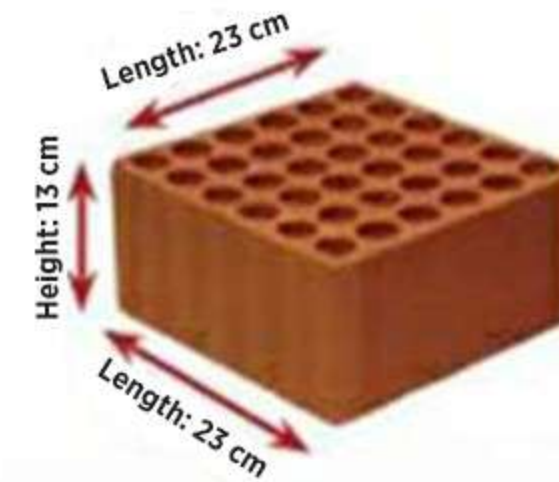

Round-Hole Masonry Brick

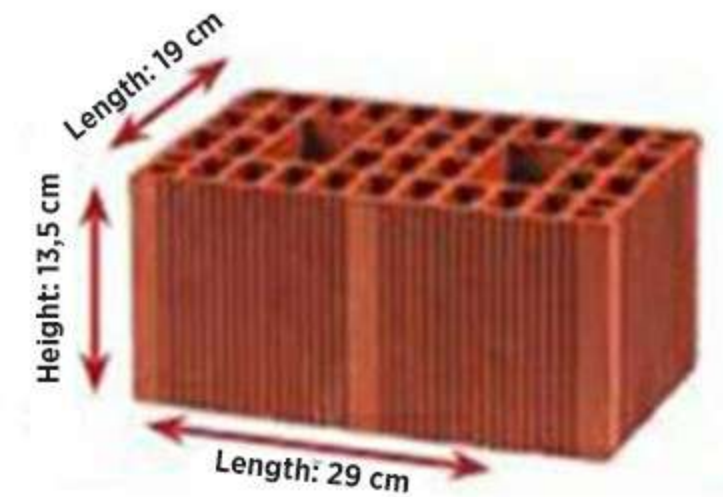

Large Masonry Brick

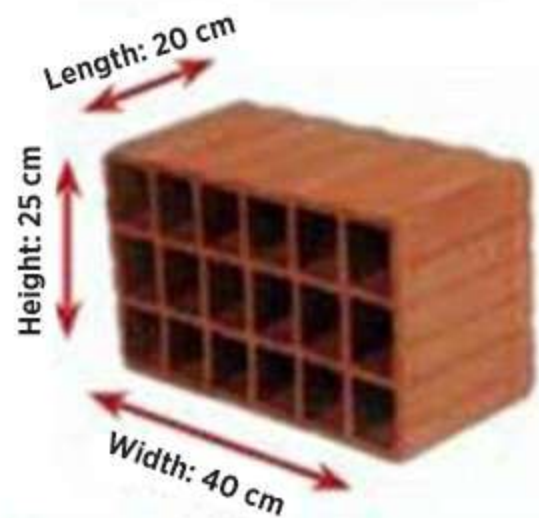

25-Infill Brick

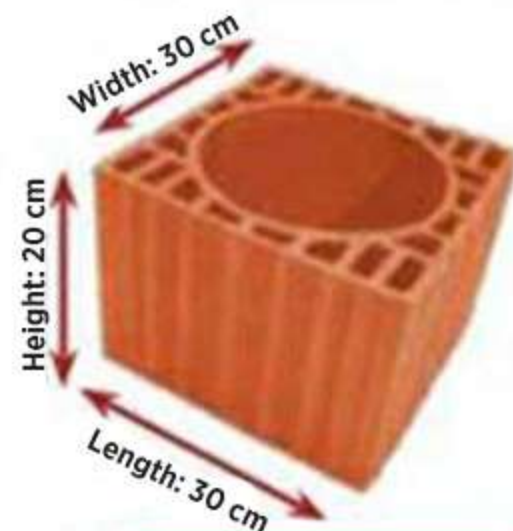

Boiler Flue Brick

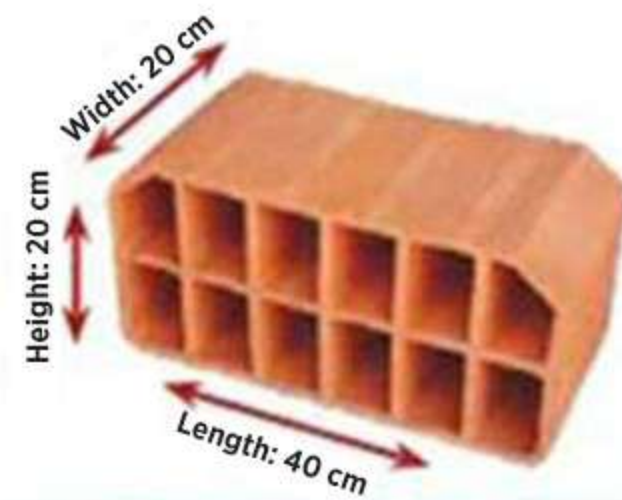

20-Infill Brick

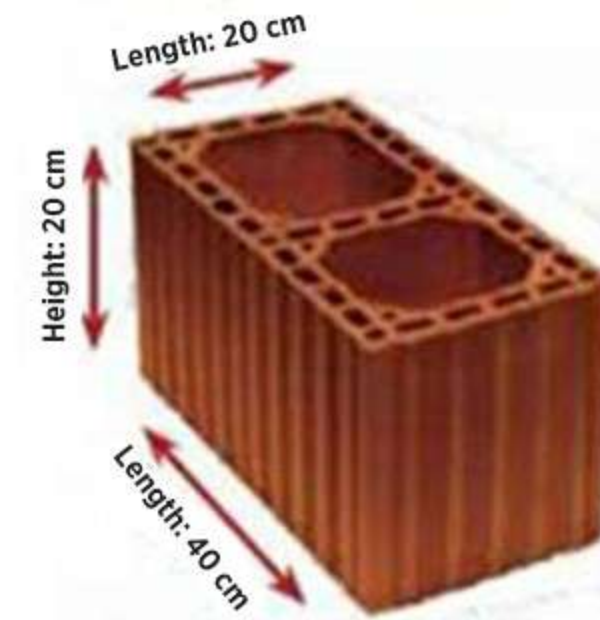

Double Shunt Brick

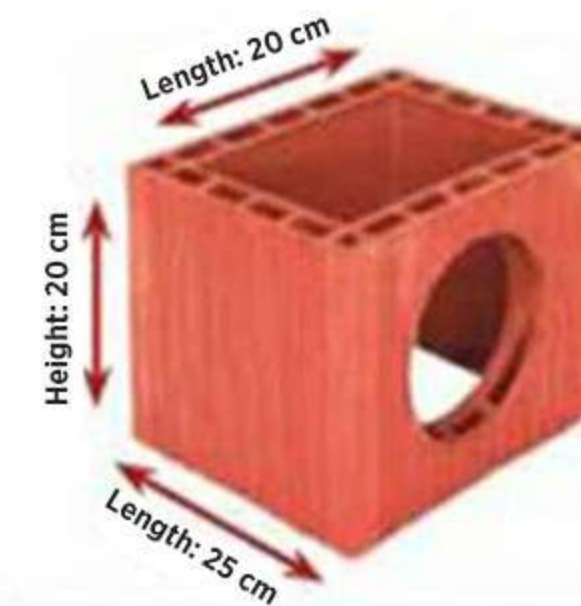

Square-Hole Masonry Brick

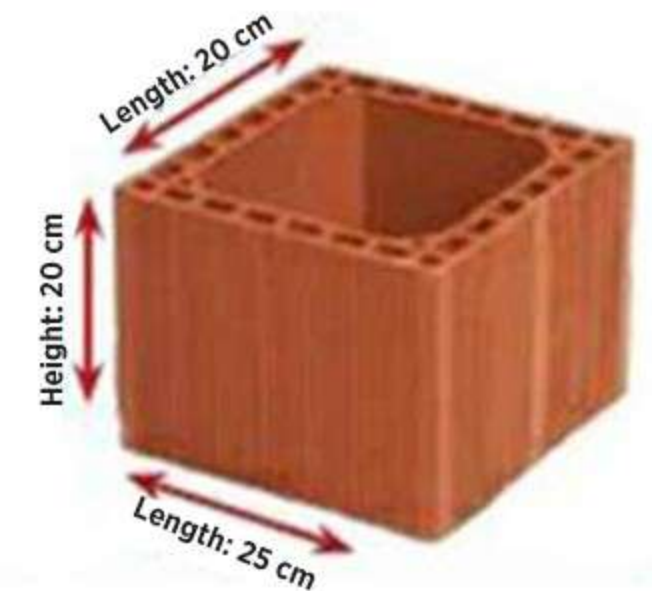

Square Flue Brick



RIBBED BAR

RIBBED BAR

A ribbed bar is used for increasing the strength of the concrete.

It is composed of carbon and manganese elements and is safely used in construction projects thanks to its threaded structure.

WHY RIBBED BAR?

The most important point to consider in terms of static and dynamic load in construction is the yield strength of construction steel. In addition, the elongation and tensile strength of the bar are considered in recent times.



Nominal Diameter (D) (mm)	Peripheral Length (cm)	Nominal Mass (kg/1m)	Peripheral Length (mm)	Nominal Mass (kg/12m)
8	2,51	0,395	50,3	4,74
10	3,14	0,617	78,5	7,404
12	3,77	0,888	113	10,656
14	4,4	1,21	154	14,52
16	5,03	1,58	201	18,96
18	5,65	2,00	254,4	24
20	6,28	2,47	314	29,64
22	6,91	2,98	380	35,76
25	7,54	3,85	491	46,2
28	8,17	4,83	616	57,96
30	8,8	5,55	706,5	66,6
32	9,43	6,31	804	75,72



gölgeyap

MESH REINFORCEMENT

AREAS OF USAGE:

Reinforced concrete construction decks;

Beamless floors, ribbed floors, normal reinforced concrete plates;

Pad and raft foundations;

Concrete runway, highway, and field concrete;

Water structures; dams, canals, and flumes;

Prefabricated structural components;

Various constructions of industrial structures, suspending ceilings, fences, etc.;

Subway and tunnel constructions.

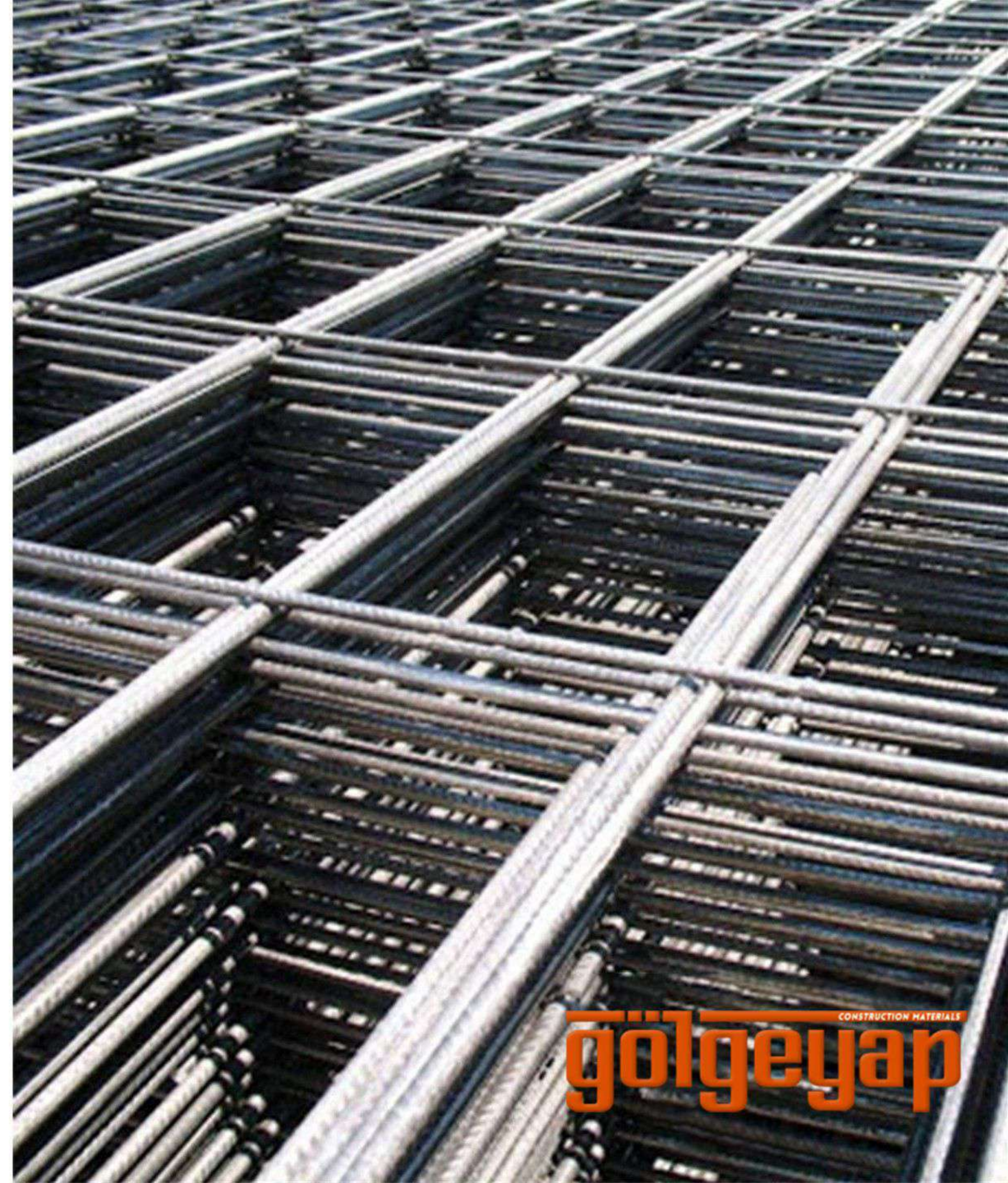



WIRE ROD

AREAS OF USAGE:

Stirrup, miter, bent bar, tie spacer, bored pile accessories;

Wire manufacturing, wire rod production, nail and concrete wire;

High-strength wire-spring-ropes manufacturing;

Bolt-nut-screw manufacturing;

Welding wire and electrode manufacturing;

Pretensioned concrete wire manufacturing;

Flat spring manufacturing due to the fatigue strength of parts such as discs and cutters of agricultural machinery and concrete breaker etc. that need to have impact and abrasion resistance.

ADOCİM®

gölgeyap

BULK CEMENT STRENGTH CLASSES

CEM I 42,5 R

CEM II/A-P 42,5 R

CEM IV/A (P) 42,5N-SR

CEM IV/B (P) 32,5N-LH SR

BAGGED CEMENT STRENGTH CLASSES

CEM I 42,5 R

CEM IV/B (P)

32,5N-LH SR

CEM IV/B (P) 32,5N-LH SR 25kg

BAGGED CEMENT STRENGTH CLASSES

CEM I 42,5 R

CEM IV/B (P) 32,5 N

CEM IV/B (P) 32,5 N 25kg

Bulk Cement Strength Classes

CEM I 42,5 R

CEM II/A-LL 32,5 N

BAGGED CEMENT STRENGTH CLASSES

CEM I 42,5 R

CEM II/A-LL 42,5 R

CEM II/B-LL 32,5 N

Bulk Cement Strength Classes

CEM I 42,5 R

CEM II/A-LL 42,5 R

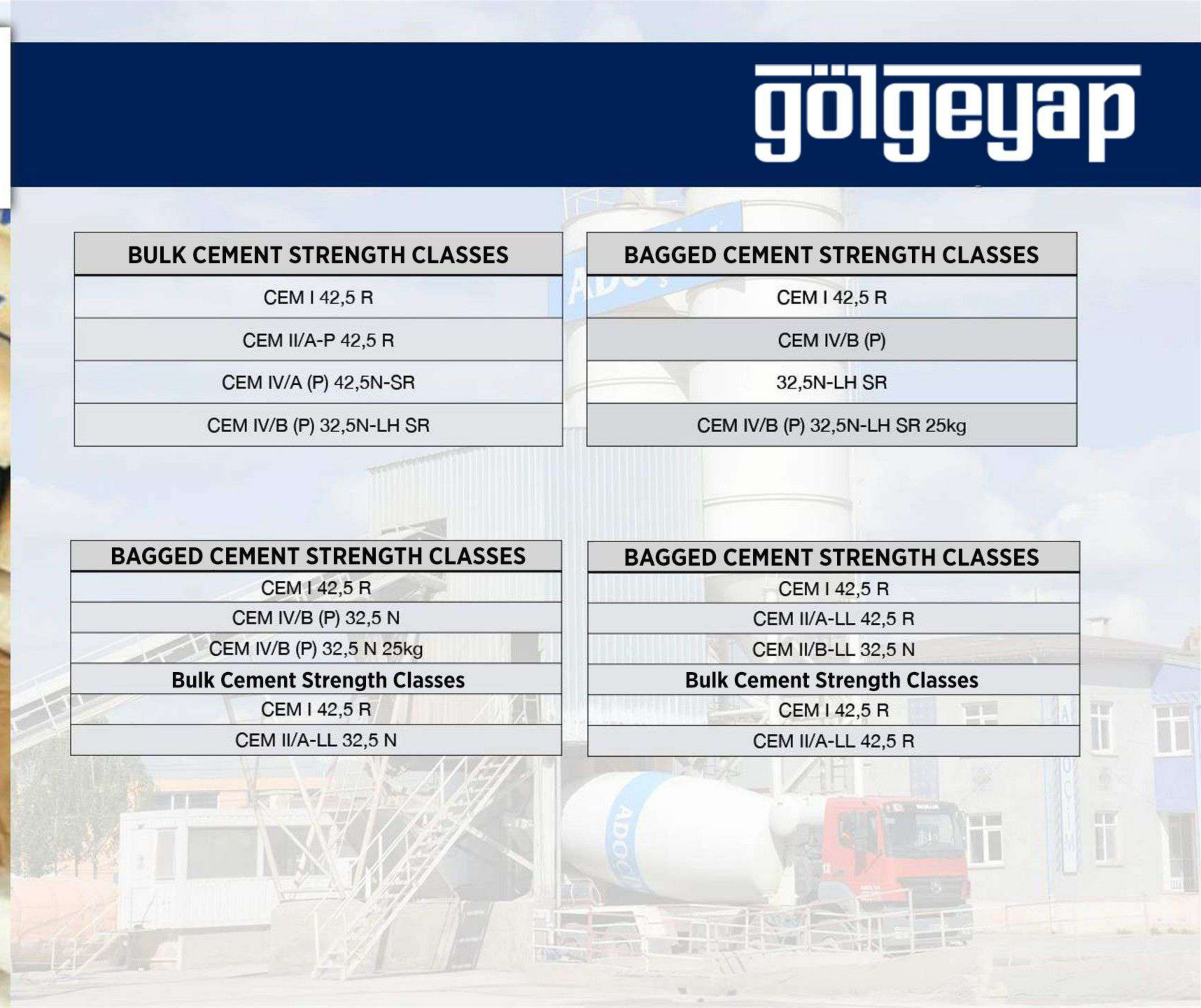

**WE ARE HERE FOR YOU
TOGETHER WITH THE
PROFESSIONALS OF THE
BUILDING SECTOR!**



gölgeyap

 Atisan Sanayi Sitesi 1567. Sk.
No: 2-4 Yenimahalle / Ankara

www.golgeyapigrup.com 

 +90 (212) 416 36 36
 info@golgeyapigrup.com